

AARP Foundation®

Home Upkeep Guide



Live Comfortably and Affordably in Your Home for Years to Come

Table of Contents



1 Why Home Maintenance Is Important	1
2 Budgeting	5
3 DIY vs. Bringing in a Professional	6
4 Make Your Plan	9
5 Find Help	15
6 Putting It All Together	20
7 How-To Guides	22

1 | Why Home Maintenance Is Important



Do you want to stay in your own home as you grow older?

If you're over 50, it's time to give this question some thought, so you can plan for your future.

Most people want to stay in their own home, keeping their normal routine, maintaining their connections, and enjoying a higher level of control over where they live.

Keeping your home in good condition through regular home maintenance can help you do just that.

When done correctly, home upkeep tasks can help you:

- **Stay safe** by reducing your risk of fires and falls at home
- **Save money** by lowering your utility bills, extending the life of your appliances, and preventing costly repairs
- **Stay healthy** by lowering your risk of illness, disease, and injuries

Taking care of your home is an ongoing responsibility – and it can seem like a never-ending list of to-do's. Believe it or not, sticking to a home maintenance routine can make these tasks more manageable – and affordable.

In this guide you'll find tips and recommendations for budgeting, planning ahead for big expenses, and accessing free and low-cost services that can help you keep your home in good condition for years to come.



Get More Resources to Ease Your Budget

Visit my.aarpfoundation.org to discover tips for securing the essentials, including saving on household expenses, earning extra income, help finding employment, and resources for helpful assistance programs.

Benefits of Home Maintenance



Risks of Not Performing Home Maintenance

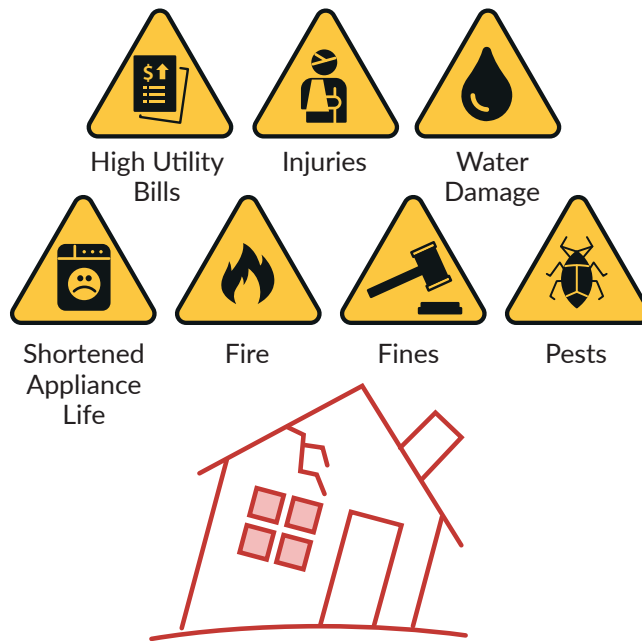

Welcome to Your Home Upkeep Guide

For more than 60 years, AARP Foundation has been helping people find affordable ways to secure the essentials, especially for their homes. We created this guide to help you keep your home in good condition through every phase of life.

Every activity in this guide was chosen specifically to help you live comfortably – and affordably – in your home as you grow older. We've gathered useful checklists, worksheets, and how-to guides from home maintenance experts to help you easily see what may need tending to around your home.

You'll get:

- Tips for staying safe and saving money with home maintenance
- Cost estimates to help you plan and prioritize maintenance activities
- Advice on getting affordable help with maintenance tasks

Ready for your routine? Let's get started!

2 | Budgeting

Taking care of your home requires an investment of time and energy, as well as money. Establishing a home maintenance routine and budgeting for activities in advance can help you make home maintenance easier, less expensive, and more predictable.

Here are a few practical tips for home maintenance budgeting:

- **Budget for ongoing maintenance *each month*.** Use the estimates in this guide to help you predict your monthly home upkeep costs. Depending on where you live, the type of house you live in, and which tasks need doing, your monthly expenses will vary.
- **Plan for big, one-time costs.** Think about parts of your home that will need replacing or major repairs, such as appliances, roofing, paint, and plumbing fixtures. Because repairs and replacements tend to be much more expensive than ongoing upkeep, it's important to prepare for these costs. Use the **My Appliance Tracker** worksheet on page 14 to help you estimate when to repair or replace major appliances and other parts of your home.
- **Set money aside regularly,** if you can. Once you have an idea of how much you can afford to spend on home maintenance, consider putting money aside every month into a “home maintenance fund” or a savings account, if you're able.

There may be free or low-cost services for home maintenance and repairs in your area. Visit my.aarpfoundation.org to get started.

3 | DIY vs. Bringing in a Professional

When it comes to home maintenance tasks, one of the most important decisions you'll make is whether you do it yourself (DIY) or hire a professional.

Before hiring someone to help with a chore or project around your home, think about whether you can safely and affordably do it yourself or with the help of a friend, family member, or neighbor.

One major benefit of tackling home maintenance yourself: you save money. A recent study by AARP Foundation found that homeowners can save nearly \$2,000 a year on average if they manage their most important maintenance tasks themselves, rather than hiring a professional for everything.¹

While maintenance can get more challenging with time, tackling these tasks by yourself can be very rewarding. Mastering a new skill — for example, learning how to change an air filter or how to tighten loose water connections — can help you feel safer and more confident in your home as you grow older.

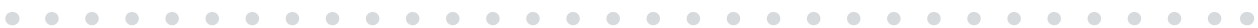

A Word of Caution. *The instructions in this guide are general suggestions only. Please read the full Disclaimer at the end of this guide.*

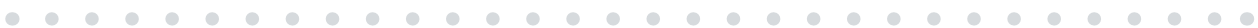

1. Michael Eriksen, Ph.D., Maintaining Homes to Age-in-Place: Recommendations and Cost Projections for Older Homeowners, AARP Foundation (2018).

When to Hire a Professional

Regardless of how handy you are around the house, there are some tasks that are simply too difficult, risky, or time-consuming for most homeowners – like cleaning upper-level windows or servicing your boiler.

Below are some home maintenance tasks that should be done at least once a year and require a professional's attention. Please note that this list is not comprehensive. Although there are other tasks you can hire a professional to do around your home, this list includes the top recommendations from home maintenance experts for keeping your home in good condition as you age.

	RECOMMENDED PROFESSIONAL	When to perform			
		SPRING	SUMMER	FALL	WINTER
GENERAL EXTERIOR					
Remove debris from gutters and downspouts	General handyman	✓		✓	
Trim or remove trees/shrubs hanging over or touching your roof	Tree-trimmer	✓			
Clean upper-level windows and screens (for a multistory home)	Window cleaner	✓			
GENERAL INTERIOR					
Inspect and sweep chimney (if you have and use a fireplace)	Chimney serviceman			✓	
Service air conditioner	HVAC specialist	✓			
Service boiler or furnace	HVAC specialist			✓	
Inspect dryer vents	HVAC specialist	✓			
Service hot water heater	HVAC specialist	✓			
Inspect electrical system, including outlets and wiring	Electrician	✓			

7 Tips for Hiring a Professional

1. **Make a list of what you need done.**
2. **Get recommendations from family and friends.** Don't trust professionals that come to your door uninvited. (Visit AARP's Fraud Watch Network for more about protecting yourself from scammers.)
3. **Check recommendations.** Check the Better Business Bureau for complaints against the contractor or company.



AARP's Fraud Watch Network
aarp.org/money/scams-fraud
1-877-908-3360

Better Business Bureau
bbb.org
1-703-276-0100

4. **Ask for proof of credentials and insurance.** Never hire someone without checking that they have proper certifications, licensing, and insurance.
5. **Ask for estimates.** Estimates should detail materials, labor charges, start and end dates, and total cost.
6. **Get everything in writing.** Don't approve plans you don't understand. Never sign a contract with blanks, and keep a copy of everything you sign.
7. **Don't pay the final bill until all work is completed.** If doing a larger project like a remodel or renovation, make sure the required building authorities inspect the work, and get a written statement that the contractor has paid all subcontractors and suppliers.

4 | Make Your Plan



Now that you understand the importance of budgeting, and know how to decide whether to DIY or bring in a professional, it's time to begin planning your home maintenance routine.

Home Maintenance Seasonal Guide

How often should you replace batteries in smoke and carbon monoxide detectors, inspect for pest damage, or check for loose water connections?

This **Home Maintenance Seasonal Guide** helps you recognize when and how often to perform 16 critical home maintenance tasks. Use this guide to identify any gaps in your current routine and prioritize tasks by season.



Do It Yourself – General Exterior

Use this form to plan your maintenance routine year-round. Write the date you complete each maintenance activity in the white spaces.

KEY



Regular maintenance required. Write in the date when it was last completed so you have a record.



Regular maintenance should not be required at this time.

	When to perform			
	SPRING	SUMMER	FALL	WINTER
Take care of your yard (mow lawn, rake leaves, remove debris, apply mulch)	CHECK MONTHLY			
Prevent and check for pest damage				
Check for gaps in seals around windows and doors				
Prepare external water-lines for winter				
Remove snow and ice from pathways				

Do It Yourself – General Interior

	When to perform			
	SPRING	SUMMER	FALL	WINTER
General housekeeping	CHECK MONTHLY			
Replace burned-out lightbulbs	CHECK MONTHLY			
Test and replace batteries in smoke and CO detectors				
Replace HVAC air filters				
Check attic for signs of leaks	CHECK MONTHLY			
Check for loose floorboards, stair treads and handrails				
Clean dryer vent and hose				
Bleed air from radiators				
Check for loose water connections				
Check shower for missing grout or caulk				
Check toilet for pooling or running water	CHECK MONTHLY			

Professionals Only

	RECOMMENDED SERVICE PROVIDER	When to perform			
		SPRING	SUMMER	FALL	WINTER
Remove debris from gutters and downspouts	General handyman				
Trim or remove trees/shrubs hanging over or touching your roof	Tree trimmer				
Clean upper-level windows and screens (for a multistory home)	Window cleaner				
Inspect and sweep chimney (if you have and use a fireplace)	Chimney sweep				
Service air conditioner	HVAC specialist				
Service boiler or furnace	HVAC specialist				
Inspect dryer vents for fire hazards and airflow	HVAC specialist				
Service hot water heater	HVAC specialist				
Inspect electrical system, including outlets and wiring	Electrician				

Track Your Appliances

Eventually, you'll need to replace major appliances like your dishwasher or furnace, as well as other parts of your home like roofing and paint. To help you plan for these future costs, refer to this list of appliances you likely have in your home, their useful life, and estimated costs to replace them.²

APPLIANCE AND PART REPLACEMENT	AVERAGE USEFUL LIFE (IN YEARS)	ESTIMATED COST TO REPLACE (NATIONAL AVERAGES)
Washing machine hose	4	\$21
Dishwasher	9	\$500
Microwave	9	\$200
Water heater	10*	\$1,332
Washing machine and dryer	10	\$750
Sump pump	10	\$350
CO/smoke detectors	10	\$28
Refrigerator	11	\$900
Air conditioning/central air	13	\$4,463
Oven/stove	13	\$650
Garage door opener	13	\$249
Gas furnace	18	\$2,755
Roof shingles	20	\$2,346

2. Michael Eriksen, Ph.D., Maintaining Homes to Age-in-Place: Recommendations and Cost Projections for Older Homeowners, AARP Foundation (2018).

* Water heaters can wear out more quickly depending on the type of water in your area. Hard water reduces the average useful life of a water heater.

My Appliance Tracker

Use this worksheet to keep track of your appliance warranty numbers, inspections and repairs.

	YEAR PURCHASED/ INSTALLED	ESTIMATED YEAR TO REPLACE	MANUFACTURER/ CONTACT	WARRANTY NUMBER	DATE LAST INSPECTED/REPAIRED
Dishwasher					
Microwave					
Water heater					
Washing machine and dryer					
Sump pump					
CO/smoke detectors					
Refrigerator					
AC unit					
Oven/stove					
Garage door opener					
Heating unit					

5 | Find Help

As you age, you may find it difficult and even unsafe to continue doing the same tasks you once did yourself. Family, friends and neighbors can be a great help in taking care of your home, but there will likely be projects that require additional assistance.

That's when it's useful to call on **volunteer-based services** or **government assistance**.



Get More Resources to Ease Your Budget



Visit [my.aarpfoundtion.org](https://my.aarpfoundation.org) to discover tips for securing the essentials, including saving on household expenses, earning extra income, help finding employment, and resources for helpful assistance programs.



Volunteer-Based Services

Need something done around your house, but can't afford to pay for it or don't know who to trust for help? Consider looking for free or low-cost volunteer-based assistance in your area. Many charitable organizations throughout the U.S. offer free or discounted services — ranging from changing lightbulbs to replacing roofs — for low-income and older homeowners.

Government-Based Services

City, state, and federal government programs can help you lower the cost of home upkeep through grants, loans and tax credits. These programs cover a range of services, from minor home repairs to help with paying your utility bills.

Examples of home improvement projects that could qualify for government assistance include:

- Lowering utility bills.
- Repairing major building problems, such as replacing a damaged roof.
- Improving your ability to move safely around your home, such as installing grab bars, handrails or ramps.
- Finding and removing health and safety hazards, such as lead paint or mold.

Be prepared to provide documentation to prove that you qualify for assistance for these types of services. Types of documents include:

ELIGIBILITY REQUIREMENT	DOCUMENT(S) TO SUBMIT AS PROOF
<p>The house that needs work is your permanent residence.</p>	<ul style="list-style-type: none"> • The deed to your house • Most recent mortgage statement
<p>You are up to date on your taxes and home insurance payments.</p>	<ul style="list-style-type: none"> • Homeowners insurance policy • Tax returns • Most recent property tax statement
<p>You earn below a certain income level, given the size of your household (this amount will vary by location), and you cannot access a private loan to pay for the work on your home.</p>	<ul style="list-style-type: none"> • Pay stubs or proof of Social Security income • Credit report
<p>One or more of the following statuses applies to you: senior, veteran, or person with disabilities.</p>	<ul style="list-style-type: none"> • Birth certificate • Government-issued photo ID (such as a driver's license or passport)

5 Tips for Locating Government Assistance Programs

- 1. Look online.** Visit my.aarpfoundation.org to discover benefit programs that may help with your everyday expenses like groceries, utilities, phone, internet, and healthcare.
- 2. Call 311.** The free, local assistance 311 line connects residents in many cities with information and resources in their area. Dial 3-1-1 and ask the operator to help you find home improvement services through your local government.
- 3. Contact your local government officials.** Get in touch with your city or county government directly and ask about funding available to help keep your home in good condition.
- 4. Contact a housing counseling agency.** Certified by the U.S. Department of Housing and Urban Development (HUD), housing counseling agencies can help you find and apply for local government programs. Visit HUD's Housing Counseling website (hud.gov/counseling.) or call the HUD Housing Counseling line at 1-800-569-4287 to find an organization in your area.
- 5. Find your local Area Agency on Aging.** Area Agencies on Aging are local organizations designed to provide services, referrals and advice to older adults in communities throughout the U.S. Contact your local agency and ask them to connect you to home improvement programs in your community. To locate an agency in your region, search the Eldercare Locator website (eldercare.acl.gov) or call 1-800-677-1116.

7 Tips for Working With Volunteer and Government Support Services

Use the tips below to access the services you need from volunteer-based or government organizations.

- 1. Identify the problem(s) you're facing and write them down.** Write some notes about the challenge(s) you face in taking care of your home. Include details about dates, how long the problem has existed, the impact the challenge has on your life, and any attempts to resolve it. When you call or visit an organization to ask for assistance, look to your notes to explain your situation.
- 2. Contact multiple providers and compare services.** You might qualify for more than one type of assistance. Talk to a few different providers to compare services and make sure you've found the best option.
- 3. Take detailed notes and keep records.** Make sure you write down the information you receive and save it so you can come back to it in the future.
- 4. Understand your options.** When you contact a provider, be friendly and confident in asking questions. Remember: You have a right to understand the services available to you.
- 5. Be prepared to go through an application process.** Ask the provider if you are eligible to apply for this assistance and what information you need to supply. (See the Eligibility Requirements table on page 17.)
- 6. Ask for referrals.** If one agency or organization can't help you, ask them to refer you to another that can.
- 7. Before signing anything, make sure you understand the program's terms.** If you access a government loan program, for instance, make sure you understand repayment terms. If you use a charitable service, find out if you need to put money or labor toward the work.

6 | Putting It All Together

Chances are you already do many of the home maintenance activities we recommend, like housekeeping and preparing for winter weather. Some of the activities, like inspecting your furnace, may be new to you and probably require professional help. That's normal!

This home upkeep guide to help older adults — and the people who support them — fill the gaps in home maintenance knowledge and put together a *home maintenance routine that fits their changing needs with each phase of life*. The goal is keep your home safe, healthy and affordable, so you can stay there as long as you'd like.



Keeping up with regular home maintenance can present new challenges as we grow older. Making a plan to tackle these challenges takes time, but it's worth it: You'll feel safer and more confident in your home.

Take it step-by-step; the checklists and worksheets included in this guide will help you plan and prepare. They were designed by home repair experts to help you focus on the activities that matter most when it comes to staying safely in your home for a lifetime.

Remember to search for and ask for help when you need it. Friends, family members or neighbors might be able to help you. You can hire professionals or paid help for almost every task in this guide, and there are also volunteer and government assistance programs that could perform the work or provide financial support.



7 | How-To Guides

Ready to tackle a home maintenance task? These How-To Guides are loaded with helpful tips, whether you DIY or hire a professional.



Information included in these guides came from a variety of sources, including home repair specialists, home insurers, and organizations such as the Centers for Disease Control and Prevention, the U.S. Environmental Protection Agency, and the U.S. Department of Energy. For more tips and information, visit our website: my.aarpfoundation.org/homeupkeep.







The instructions contained in this guide are general suggestions only. Please use caution and sound judgment when deciding whether to attempt the activities described herein, and consult your physician if you have questions. AARP and AARP Foundation are not liable for any physical harm incurred by individuals attempting the activities described herein. Please use caution when selecting a contractor or third party to assist you with home repairs. AARP and AARP Foundation are not liable for the acts of third-party contractors. The mention of a product or service herein is solely for information and education and may not be used for any commercial purpose.

Copyright ©2023 by AARP Foundation. All rights reserved.

Benefits of Home Maintenance

The following How-Tos cover some common tasks, and are grouped in three sections: exterior, interior, and plumbing.





BENEFITS

 Lower Utility Bills	 Avoid Fines	 Extend Appliance Life	 Prevent Pests
 Prevent Water Damage	 Prevent Home Fires	 Prevent Falls, Injuries or Illness	

Required Abilities

Most homeowners should be able to handle some or all of the following activities. If you are unsure of your abilities, seek the help of a family member, friend, or skilled professional. To help you decide which tasks are “do-it-yourself” and which are not, the icons below are included to indicate required skills.

REQUIREMENTS

 Lifting or pushing a certain amount of weight	 Using common hand tools	 Bending down or crouching
 Climbing a ladder (3ft+)	 Climbing a stepladder (up to 3ft)	

Understanding Cost Estimates

Each How-To Guide includes cost estimates for doing the task yourself or hiring a professional. It is important to note that:

- Cost estimates are for performing the task just once. Many tasks need to be performed multiple times per year.
- Cost estimates for supplies are based on costs of materials found at major U.S. retail stores.

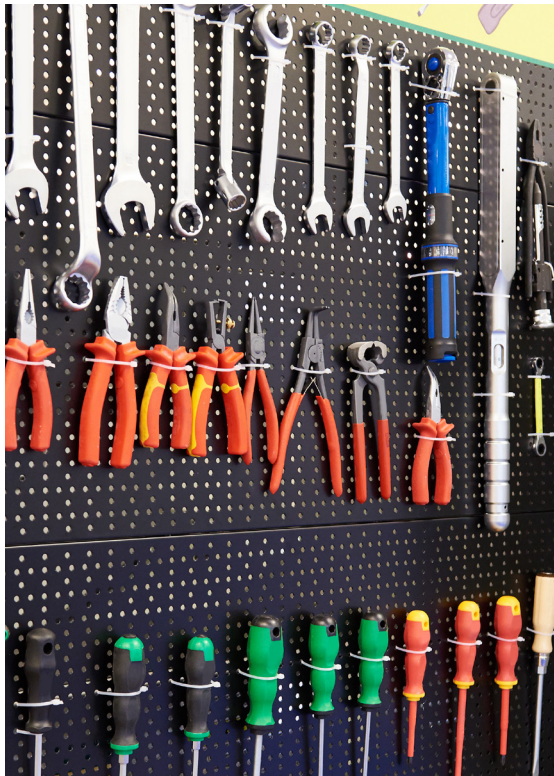

- Cost estimates for hired professionals are drawn from research commissioned by AARP Foundation, and based on cost guides offered by [Porch.com](https://www.porch.com) and other online services that connect homeowners with local professionals.
- Unless a specialist is required, the labor costs for completing a task are based on an estimated hourly rate for a general, independent handyman of \$60/hour. Professionals in your area may charge more or less for services, and homeowners are encouraged to research local cost estimates on their own.

How To...

Take Care of Your Yard

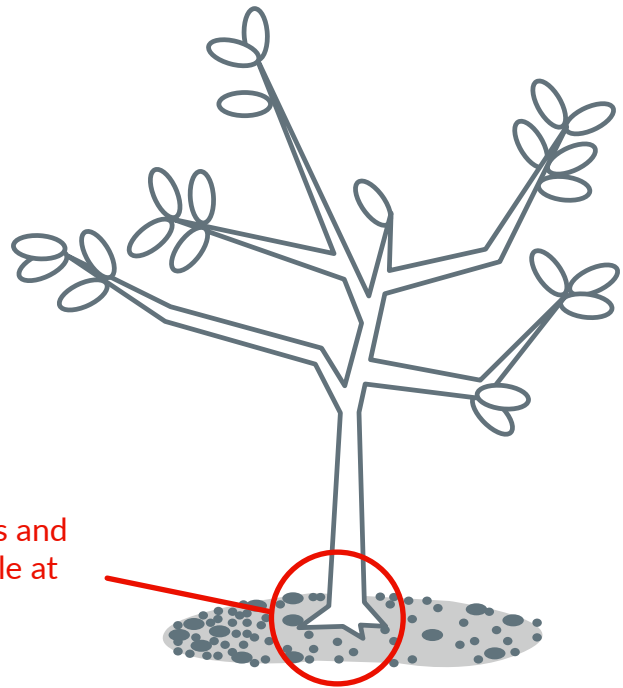

Mulch around base of trees and plants with root flare visible at the base of the trunk.

How often should I do it?

1x

per month, or as needed

What will I need?

- Lawn mower (\$135-\$280)
- 30-gallon bag for debris (\$2-\$15 each)
- Mulch (\$150-\$450)
- Rake (\$20-\$60)

What will it cost?

- Supplies: \$2-\$805
- Hire a pro: \$200-\$400

Physical Requirements



Take Care of Your Yard

Tips for Yardwork Activities

- **Remove debris:** Get rid of any fallen branches, trash, or other debris — especially close to the foundation of your home.
- **Apply mulch:** Use mulch on the base of your trees and plants.
- **Mow your lawn and pull weeds:** Mow your lawn monthly, or as needed, and pull or trim weeds.
- **Rake leaves:** Rake leaves when they pile up.
- **Simplify yard care:** Replace high-maintenance plants or grass with low-maintenance plants and ground cover.
- **Keep your home safe and dry:** Make sure sprinklers and plants are at least two feet away from your home exterior.

Make sure sprinklers and plants are at least 2 feet away from your home exterior.

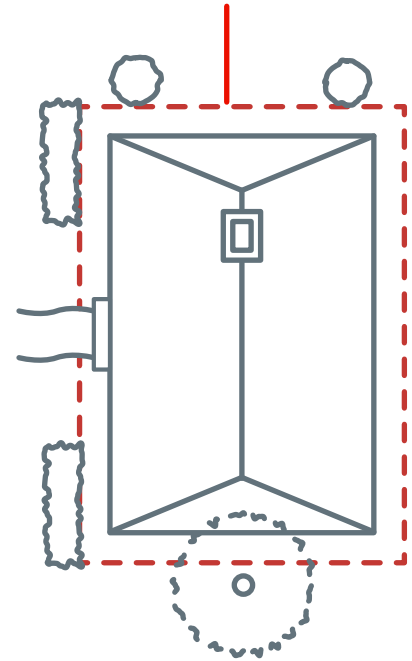

Raking Tips

- **Curbside pickup:** Check if your local government participates in curbside leaf pickup or a leaves-for-compost program.
- **Take care of your back:**
 1. Look for a lightweight rake with a curved handle.
 2. Go for a short walk and stretch your lower back and legs after raking.
 3. After raking leaves into a pile, bend at the hips, bend your knees, and lift with your legs.
 4. Lift only a handful of leaves at a time to keep the loads light.
- **Wear shoes with tread:** Prevent slipping by wearing snow boots or shoes with a gripping tread on the bottom.

How To...

Check for and Replace Missing Caulk

Doors and Windows

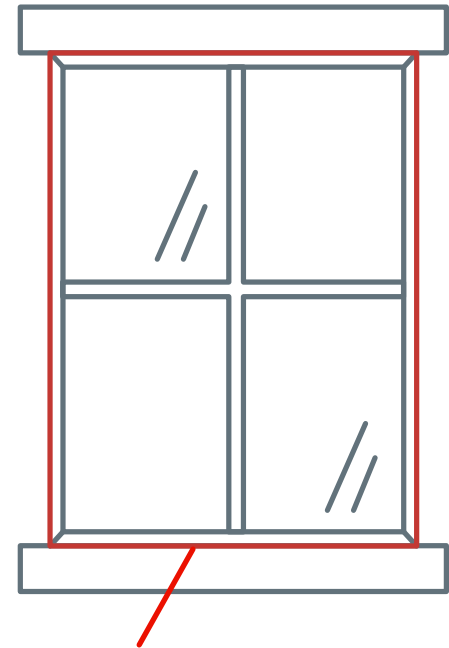

Inspect the outside of
windows and doors.

How often should I do it?

2x
per year

Inspect in spring and fall.
Remove and apply new
caulk as needed.

What will I need?

- Dripless caulk gun (\$5-\$40)
- Window and door clear silicone caulk (\$5-\$20)
- Stepladder (\$50-\$70)

What will it cost?

- Supplies: \$5-\$130
- Hire a pro: \$60-\$300

Physical Requirements



Check for Missing Caulk

Doors and Windows

How do I do it?

- 1. Inspect the outside of your windows and doors:** Look for cracked or missing caulk where your window edges meet trim, siding or brick.
- 2. Remove old, damaged caulk** with a putty knife or screwdriver.
- 3. Clean areas where you will apply new caulk** using soap or another cleaning solution.
- 4. Dry the area off** with a towel so new caulk will stick.
- 5. Using a driplless caulk gun**, hold the gun at a 45° angle to the window or door joint and **apply caulk in a consistent stream across the length of the joint.** Release the caulk trigger.

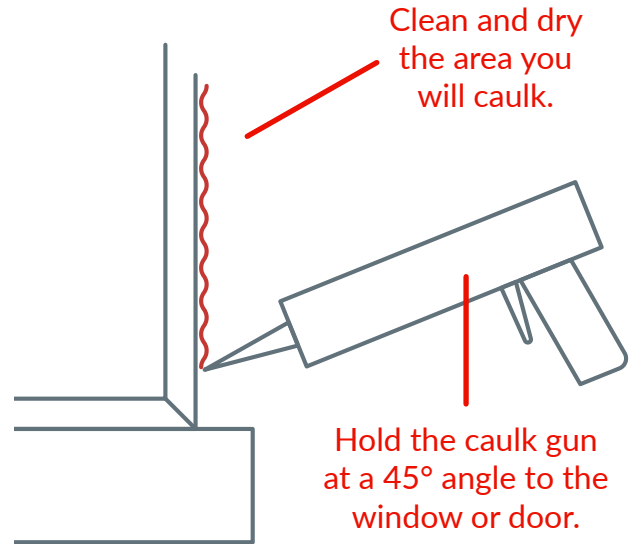

TIPS

- For second-story (or higher) windows, hire a professional to inspect and apply caulk.
- Avoid applying caulk when the outside temperature is below 45° or when it is humid.
- You'll need about half of a caulking cartridge per window or door.
- Make sure caulk sticks to both sides of the joint.
- Use a putty knife to push in any caulk that oozes out of the joint.
- If the caulk shrinks into the joint, reapply it on top of the joint to fully seal it.

How To...

Prepare External Waterlines for Winter

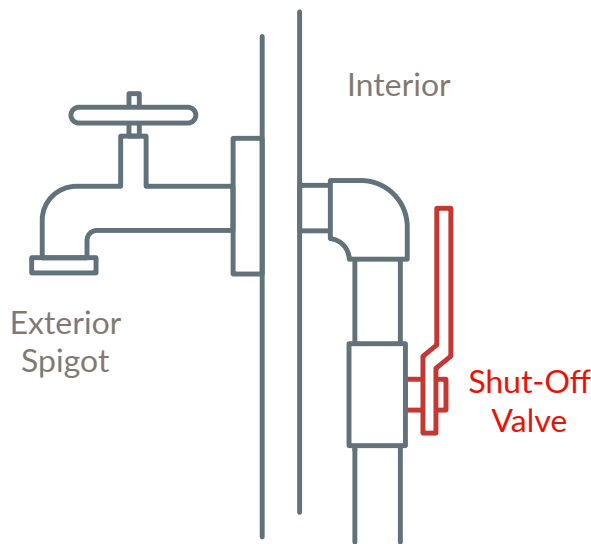

Typically the valve is on the opposite side of the wall from where the outside water spigot is located.

How often should I do it?

1x

per year, especially before the first snowfall of the year

What will I need?

- N/A

What will it cost?

- Supplies: N/A
- Hire a Pro: \$60-\$100

Physical Requirements

- N/A

Prepare External Waterlines for Winter

How do I do it?

Shut off external waterlines to keep your pipes from freezing:

1. Locate your external waterline shut-off valve. You'll typically find this valve on the opposite side of the wall from where the outside water spigot is located.
2. Turn the valve to the OFF position.
3. If there is a hose connected to the external spigot, remove and store for the season.
4. Turn the spigot on to drain remaining water, then shut it off again.

The water shut-off valve is in the OFF position when the handle is perpendicular to the pipe.

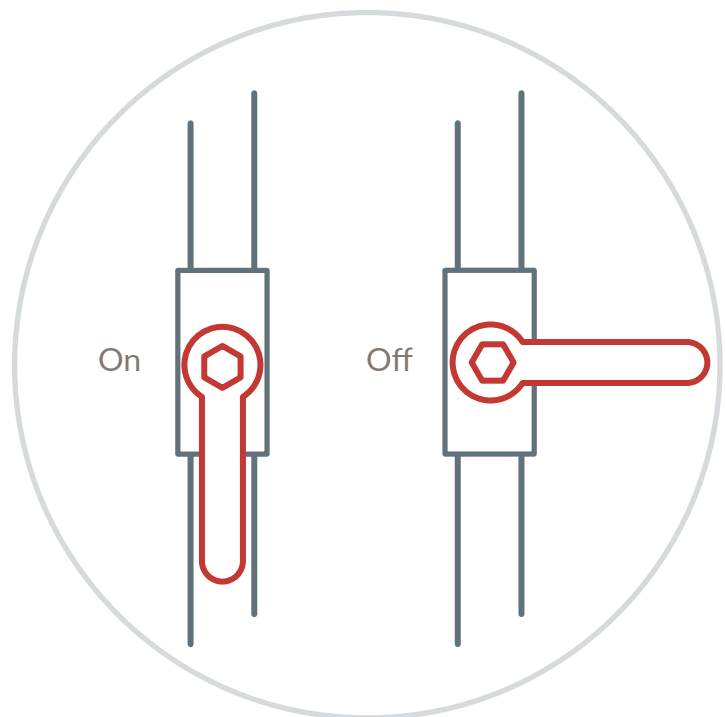

How To...

Prevent Pests

Termites/Cockroaches

Bedbugs/Mice and Rats



How often should I do it?

Periodically, as needed.

What will I need?

- Termite traps (\$18-\$100)
- Insecticide (\$15-\$30)
- Mouse traps (\$5-\$20)
- Rat traps (\$14-\$20)

What will it cost?

- Supplies: \$5-\$70, depending on pest
- Hire a pro: \$193-\$400, depending on pest

Physical Requirements



Termites

Signs of Infestation

- Pencil-thin mud “tubes” on the surface of your foundation or window sills.
- Termite wings near home exterior.
- Wood hollowed along the grain with pieces of mud or soil.



Minimize Your Risk

- Eliminate wood near home exterior; avoid using decorative wood chips.
- Use termite traps.
- Eliminate water near your foundation.
- Get your home professionally treated with pesticides.

Call a Professional...

- At the first sign of infestation, or if you want to prevent one.



Signs of termite damage: mud “tubes” on foundation surfaces and hollowed wood.

Bed Bugs

Signs of Infestation

- Reddish stains or dark dots on bed sheets or mattresses.
- Bed bug eggs and pale yellow skins.
- Small red bites on your body.

Minimize Your Risk

- Examine secondhand furniture or clothing you bring into your home.
- Wash your clothes after staying in an infested place.
- Remove clutter.

Call a Professional...

- At the first sign of infestation.





Cockroaches

Signs of Infestation

- Spotting a single roach. One roach almost always means more roaches are around.

Minimize Your Risk

- Keep your home clean.
- Seal holes inside and outside your home.

Call a Professional...

- At the first sign of infestation, or if you want to prevent one.

Mice and Rats

Signs of Infestation

- Rodent droppings, tracks or nests.
- Holes chewed through parts of your home or packaged foods.

Minimize Your Risk

- Seal holes inside and outside your home.
- Clean up open food sources and potential nesting sites.

Call a Professional...

- If you don't feel comfortable using rodent traps.



How To...

Remove Snow and Ice From Pathways



Bend at the hips,
not the lower back!



Exercise
caution.

How often should I do it?

Whenever snow accumulates around your home.

What will I need?

- Snow shovel (\$9-\$40)
- Rock salt (\$9-\$40)

What will it cost?

- Supplies: \$9-\$80
- Hire a pro: \$150-\$300

Physical Requirements



Remove Snow and Ice From Pathways

How do I do it?

Get ahead of the snow: Before a snowstorm, put salt down on the pathways near your home to help melt snow before it sticks.

Take care of your back: Using a shovel to remove heavy snow can put a strain on your back if not done properly. To keep your low back safe:

- Look for a lightweight shovel with a curved handle.
- Walk around the block to warm up your body; stretch your lower back and legs after shoveling.
- Face the snow that you want to lift straight on.
- Bend at the hips (not the low back), bend your knees, and lift with your legs.
- Lift only a little snow at a time to keep the loads light.

Protect your heart: Strenuous movement in cold temperatures can constrict your blood vessels while increasing your heart rate and blood pressure, putting some at risk of heart attack. To lower your risk:

- Talk to your doctor if you're unsure whether it's safe for you to be shoveling snow.
- Don't shovel first thing in the morning after you wake up. Give your body time to warm up.
- Use a small shovel to decrease the strain on your body and work slowly, taking frequent breaks to rest.
- Wear lots of layers to keep warm.

Wear shoes with tread: Prevent slipping by wearing snow boots or shoes with a gripping tread on the bottom.

How To...

General Housekeeping



How often should I do it?

1x
per month

What will I need?

- Paper towels (\$6-\$10)
- Sponges (\$5-\$10)
- Dish soap (\$3-\$10)
- Laundry detergent (\$8-\$15)
- Bleach (\$4-\$15)
- Disinfectant spray (\$3-\$15)
- Trash bags (\$7-\$15)
- Toilet bowl cleaner (\$3-\$15)
- Duster (\$5-\$10)
- Broom (\$10-\$30)
- Toilet brush (\$8-\$15)
- Vacuum (\$50-\$200)
- Mop (\$10-\$30)
- Scrub brush (\$4-\$10)
- Stepladder (\$50-\$70)

What will it cost?

- Supplies: \$3-\$470
- Hire a pro: \$145-\$300

Physical Requirements



General Housekeeping

Housekeeping Checklist

- Remove clutter, especially from frequently used walkways.
- Dust all surfaces.
- Wipe down and disinfect frequently used surfaces.
- Vacuum, sweep and/or mop floors.
- Clean toilets.
- Clean showers and sinks.
- Take out the trash, recycling and compost.
- Wash bedding and other linens.



How To...

Replace Burned-Out Lightbulbs

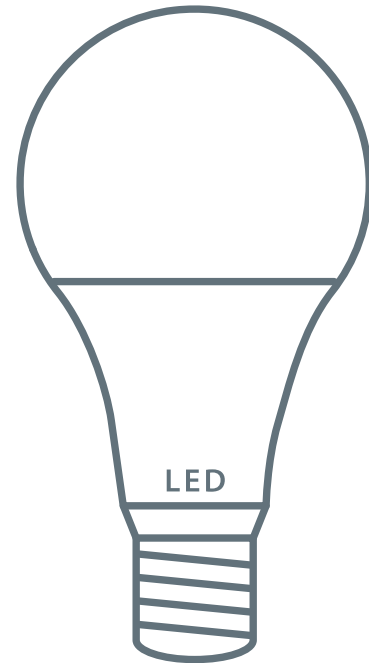

How often should I do it?

4x
per year

What will I need?

- LED lightbulbs (\$10-\$20 each)
- Bulb changer with extension pole (\$20-\$50)
- Ladder (\$70-\$150)
- Stepladder (\$50-\$70)

What will it cost?

- Supplies: \$10-\$290
- Hire a pro: \$60-\$150

Physical Requirements



Replace Burned-Out Lightbulbs

How do I do it?

1. Turn every light on and off in your home to identify bulbs that aren't working.
2. For a lightbulb that needs replacing, turn the light switch off and then unscrew the bulb.
3. Insert a new bulb and screw it in.
4. Test the bulb by turning the light switch on and off.

TIPS

- To prevent electrical shock, always make sure electric switches are turned off before removing or installing bulbs.
- Consider replacing burned-out bulbs with bulbs that produce brighter light to help illuminate dark areas that are fall hazards.
- Consider using a bulb changer with an extension pole to avoid having to use a ladder.

Bulb changer with
adjustable-length pole



How To...

Test and Replace Batteries in Smoke Alarms and CO Detectors

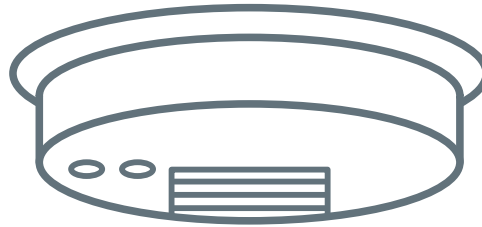

How often should I do it?

2x
per year

- Test devices: 2x/year
- Replace batteries: As needed

What will I need?

- Lithium batteries (\$12-\$20)
- Ladder (\$70-\$150)
- Stepladder (\$50-\$70)

What will it cost?

- Supplies: \$12-\$250
- Hire a pro: \$60-\$100

Physical Requirements



Test and Replace Batteries in Smoke Alarms and Carbon Monoxide Detectors

How do I do it?

1. Press and hold down the test button on the devices. If you have a combined CO and smoke detector, you can test both at the same time.
2. Within a few seconds of pressing the test button, you should hear a loud beeping noise, signaling that your alarm is working. If you don't hear the beeping noise after a few seconds, your detector might need new batteries.
3. If you replace the batteries and still don't hear a beeping noise when pressing the test button, your smoke alarm could be defective and will need to be replaced.



TIPS

- Use 10-year batteries to reduce the number of times you must replace them.
- Replace smoke alarms every 10 years.
- Clean your alarms regularly by vacuuming them using the brush attachment on your vacuum cleaner.
- Consider testing your alarms using a bulb replacement pole to avoid ladder use.

How To...

Replace HVAC Air Filters



Find an arrow indicating airflow direction on the side of the filter.

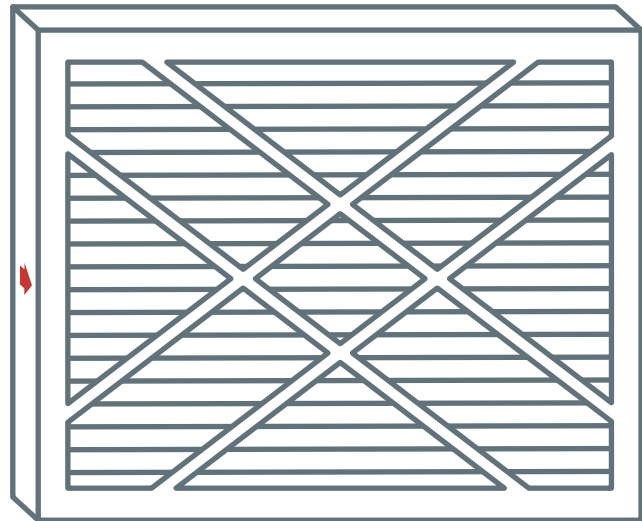

How often should I do it?

4-6x

per year depending on the type of filter and how frequently HVAC system is used.

What will I need?

- Replacement filters (\$20-\$60)

What will it cost?

- Supplies: \$20-\$60
- Hire a pro: \$60-\$200

Physical Requirements

N/A

Replace HVAC Air Filters

How do I do it?

Replacing a furnace filter:

1. Purchase a new filter that fits your furnace.
2. Turn the furnace off, open the door panel and remove the old filter.
3. Look at the edges of the replacement filter. Find an arrow indicating the airflow direction, then insert the filter with the arrow pointing toward the blower (away from where air enters the furnace).
4. Close the door panel.

Replacing an AC unit filter:

1. Purchase a new filter that fits your AC unit.
2. Remove the grill covering the filter. Most AC air filters are located in the return air duct.
3. Look at the edges of the replacement filter. Find an arrow indicating airflow direction, then insert the filter with the arrow pointing toward the air duct (away from where the air enters the grill).

TIPS

- If you have pets or live in a particularly dusty area, change your filters more frequently — as often as every month.

How To...

Check Attic for Signs of Leaks



How often should I do it?

1x
per month

What will I need?

- Flashlight (\$4-\$20)

What will it cost?

- Supplies: \$4-\$20
- Hire a pro: \$200-\$300

Physical Requirements



Check Attic for Signs of Leaks

How do I do it?

1. If you can safely access it, enter the attic.
2. Examine walls, floor, support beams, skylights, attic windows, pipes and vents, and the roof, looking for discoloration, mold, or pooling water. Remember, water can enter your attic from multiple sources, including faulty ventilation or a leaky roof.
3. If you find water or signs of water damage, call a professional.

Areas to check

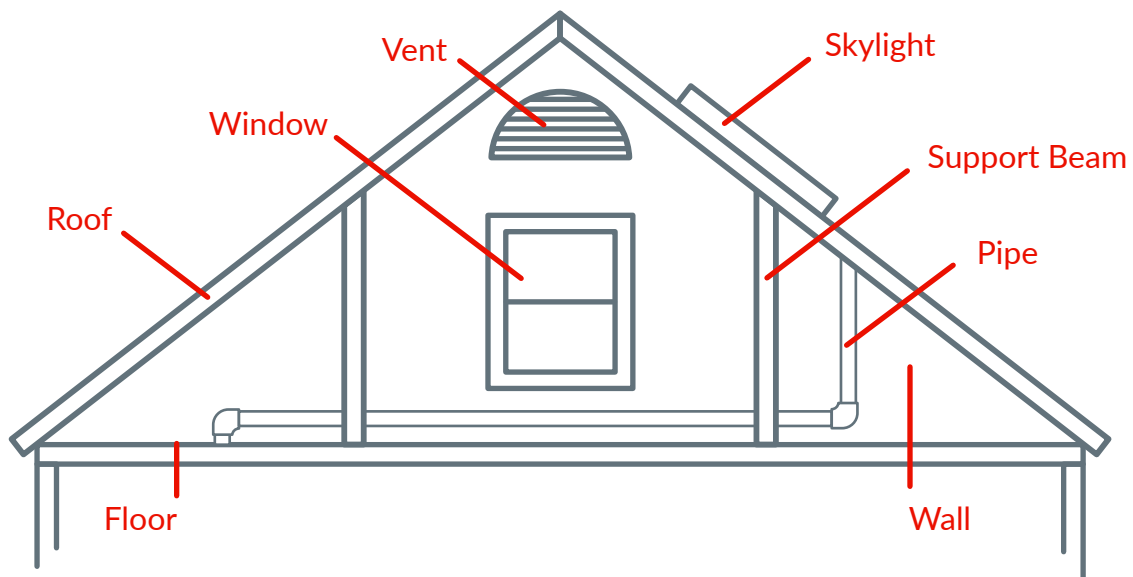

TIPS

Look carefully at roof valleys, or places where two parts of your roof join together at an angle, as these are common sources of roof leaks.

How To...

Check for Loose Floorboards, Stair Treads, and Handrails

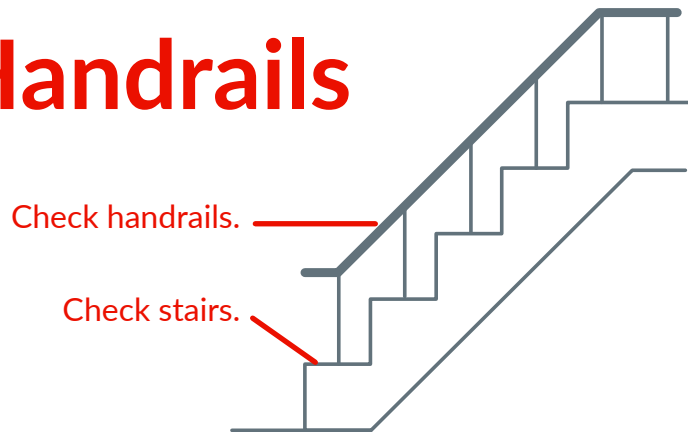

How often should I do it?

4x
per year

What will I need?

- Wood nails or screws (\$5-\$20)
- Construction adhesive (\$5-\$10)
- Hammer (\$10-\$20)
- Screwdriver (\$5-\$20)

What will it cost?

- Supplies: \$5-\$70
- Hire a pro: \$60-\$75

Physical Requirements



Check for Loose Floorboards, Stair Treads, and Handrails

How do I do it?

1. Inspect your floors, stairs, and handrails to find loose nails or screws.
2. Remove loose nails or screws with a hammer or screwdriver. Replace with new nails or screws to secure loose parts.
3. On your stairs and floors, look for gaps where the wood should be lying flat or flush against a wall. Fill large gaps with construction adhesive.

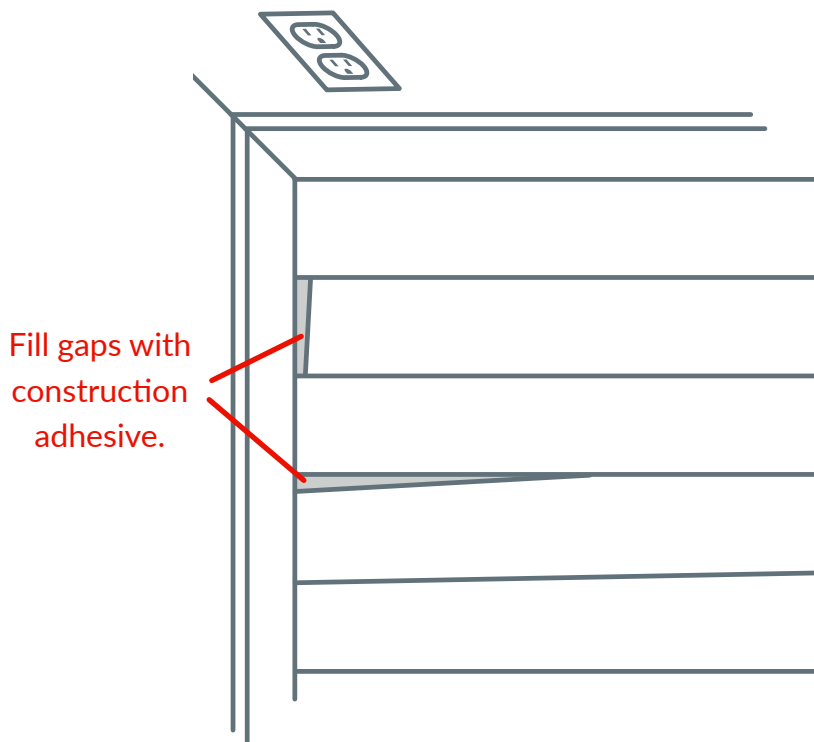

TIPS

If you see more significant damage, like stairs that have separated from their supporting wall, or unstable posts supporting handrails, call a professional to evaluate and make repairs.

How To...

Clean Clothes Dryer Vent and Hose

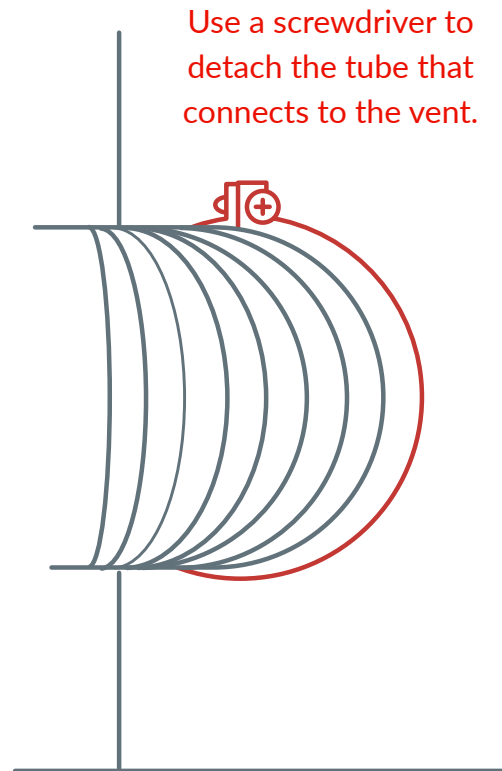

How often should I do it?

1x
per year

What will I need?

- Screwdriver (\$5-\$20)
- Vacuum with hose (\$50-\$200)

What will it cost?

- Supplies: \$5-\$220
- Hire a pro: \$150-\$300

Physical Requirements



Clean Clothes Dryer Vent and Hose

How do I do it?

1. If you are able, pull the dryer out from the wall where it is plugged in.
2. Unplug the dryer.
3. Use a screwdriver to detach the hose that connects to the vent.
4. Use a vacuum hose attachment to remove lint in the dryer vent and at both ends of the vent hose.
5. Use a screwdriver to reattach the hose to the vent.
6. Plug the dryer back in and push it back in place.

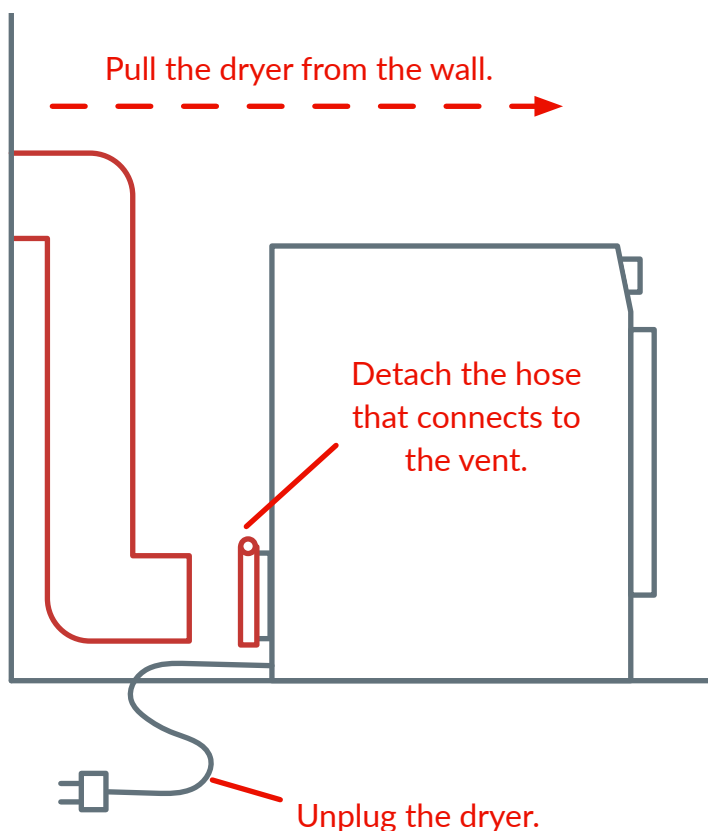

TIPS

Clean the dryer lint trap after every load to avoid dangerous lint buildup. If using a gas dryer, turn the gas valve off before cleaning the vent, and be sure to turn it back on again before putting the dryer back in place.

How To...

Bleed Air From Radiators in the Winter



If the temperature drops as you move upward, you could have air trapped in your device.

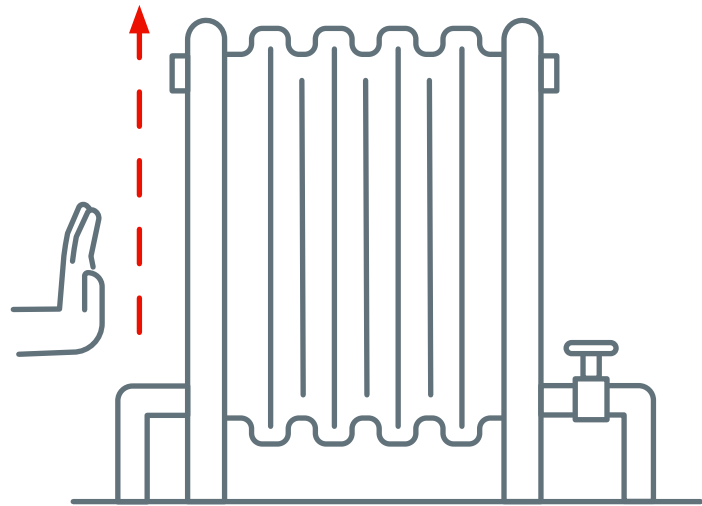

How often should I do it?

1x
per year

What will I need?

- Radiator key (\$3-\$10)
- Screwdriver (\$5-\$20)

What will it cost?

- Supplies: \$3-\$30
- Hire a pro: \$60-\$200

Physical Requirements



Bleed Air From Radiators in the Winter

How do I do it?

1. Check if your radiator has air trapped inside by turning it on and placing your hand close to the bottom of the device. You should feel heat coming out of the radiator.
2. Move your hand up toward the top of the radiator. If you notice that the temperature drops as your hand moves upward, you could have air trapped in your device.
3. Insert a radiator key or screwdriver into the valve at the top of the radiator and turn counterclockwise until you start to hear air escaping.
4. You will know that all the air has been fully released when you see water dripping out of the valve. Reinsert the radiator key or screwdriver and tighten the valve.

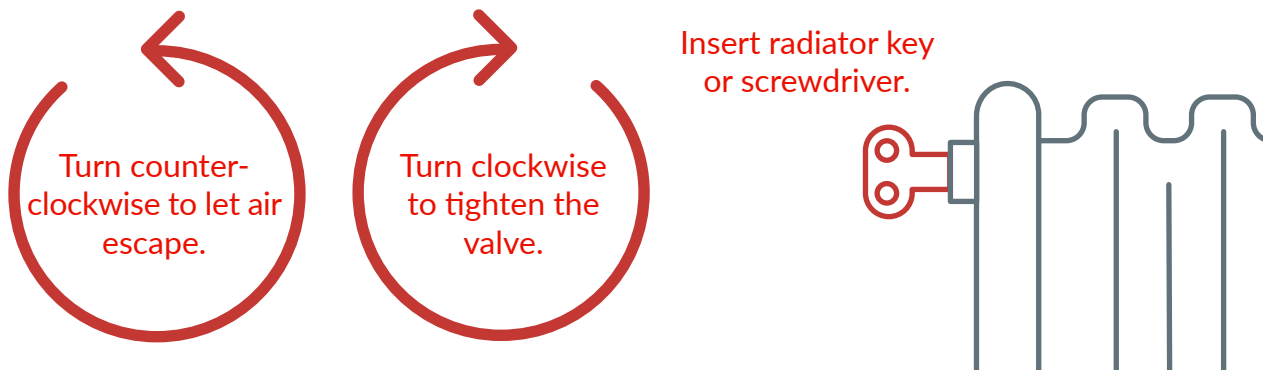

TIPS

If you live in a multistory home, start with the radiators on the upper level, then work your way down.

How To...

Check for Loose Water Connections

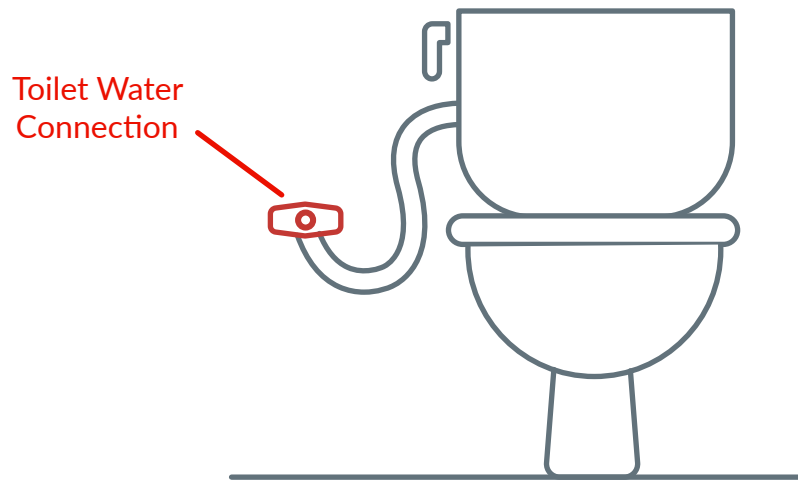

How often should I do it?

4x
per year

What will I need?

- Wrench (\$5-\$25)
- Pliers (\$10-\$20)

What will it cost?

- Supplies: \$5-\$45
- Hire a pro: \$166-\$220

Physical Requirements



Check for Loose Water Connections

How do I do it?

1. Find places where water enters your home through pipes: bathroom, kitchen, and where you do laundry.
2. Identify water connections on the walls. There will be a connection for your toilet, sinks, dishwasher, refrigerator/ice maker, and washing machine.
3. Check for water leaking from each connection.
4. If you find a leak, try tightening the joint(s) manually or with pliers or a wrench. If you're unable to do this, or if the leak continues, call a professional.

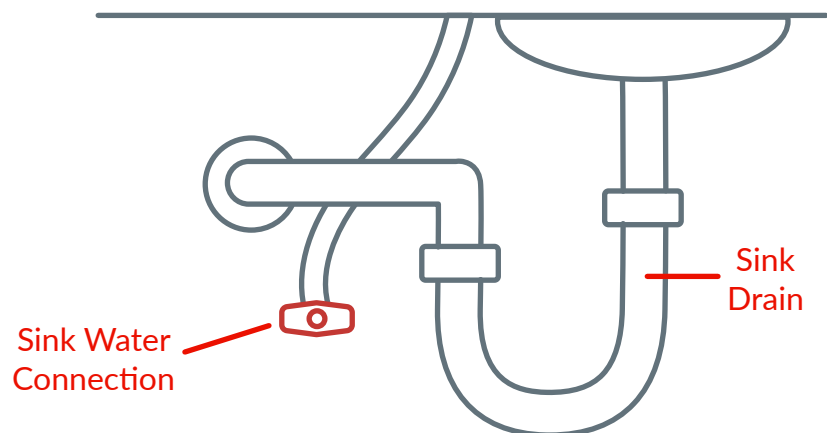

TIPS

It may be challenging to check the water connection for your dishwasher, refrigerator and washing machine, as these appliances are difficult to move. Homeowners are encouraged to call a professional to check these appliances for leaks.

How To...

Check Shower for Missing Grout or Caulk



Check for gaps or cracks between the tiles.

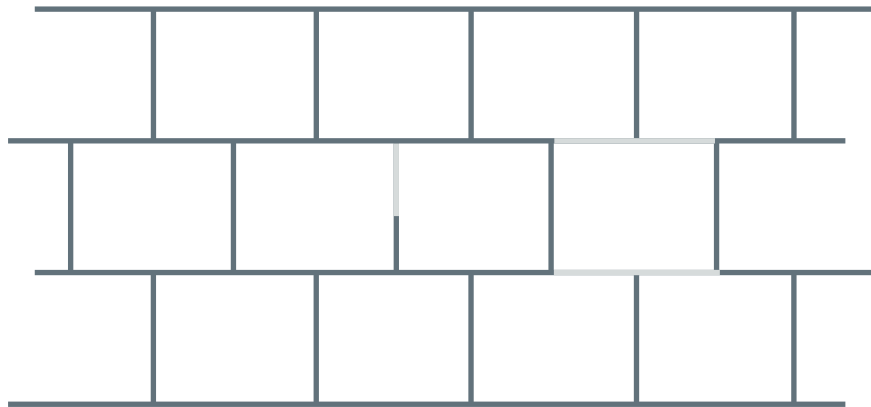

How often should I do it?

1x
per year

What will I need?

- Silicone caulk (\$5-\$20)
- Caulk gun (\$5-\$40)

What will it cost?

- Supplies: \$5-\$60
- Hire a pro: \$60-\$100

Physical Requirements



Check Shower for Missing Grout or Caulk

How do I do it?

1. Look around your shower for gaps or cracks between tiles, around edges and corners, or where two surfaces meet (for instance, where a glass panel meets a tile ledge).
2. If you see a gap, patch it yourself using silicone caulk (see “How to Check for and Replace Missing Caulk” for instructions), or call a handyman to help you.
3. If you see signs of water damage around or beneath the floor of your shower (for instance, on the ceiling immediately below your shower for a bathroom on the second story), check again for missing grout and caulk. If the issue persists, call a professional.

Check for gaps in the caulk along the seam where two surfaces meet.

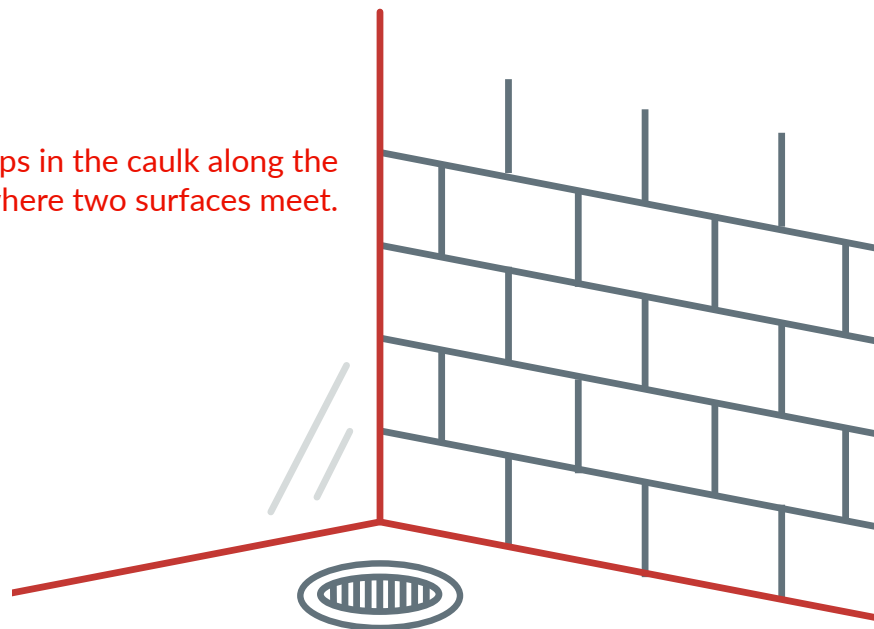

How To...

Check Toilet for Pooling or Running Water

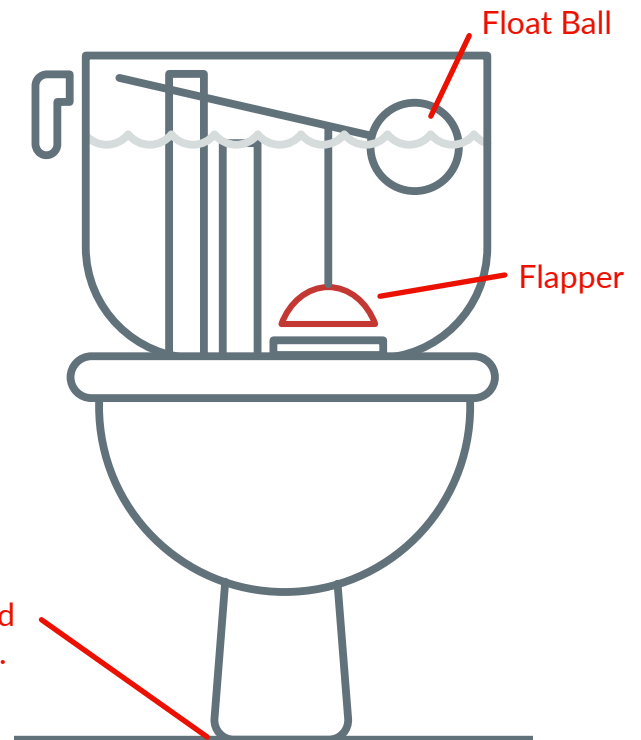

How often should I do it?

1x
per month

What will I need?

- Flapper (\$6-\$12)

What will it cost?

- Supplies: \$6-\$12
- Hire a pro: \$60-\$100

Physical Requirements



Check Toilet for Pooling or Running Water

How do I do it?

Check for pooling:

1. Examine your toilet, including the floor around the base.
2. If you detect water stains or water pooling around the base of the toilet, first clean it up with a sponge or a towel to avoid slipping hazards and to prevent water damage.
3. Call a plumber or a handyman to address the leak.

Checking for running water:

1. Listen for water that runs continuously, even when the toilet has not been recently flushed.
2. If the water is running, lift the lid off the toilet tank. Constantly running water is often caused by a faulty flapper (the device that opens and closes when the toilet is flushed), a faulty flush valve, or a blockage between these two parts.
3. Check the flapper to see if there is anything blocking it from fitting into the flush valve below it. Remove blockages. Wipe away rust or dirt from the valve and flapper, if needed.
4. If you find that the flapper is breaking down, replace it with a new flapper (found at most hardware stores).
5. If the flapper appears to be functioning properly, but the water is still running continuously, call a plumber or a handyman to inspect further.

AARP Foundation works to end senior poverty by helping vulnerable older adults build economic opportunity and social connectedness. As AARP's charitable affiliate, we serve AARP members and nonmembers alike. Bolstered by vigorous legal advocacy, we spark bold, innovative solutions that foster resilience, strengthen communities and restore hope.

AARP Foundation. For a future without senior poverty.

AARP Foundation
601 E Street, NW
Washington, DC 20049
aarpfoundation.org

 [facebook.com/AARPFoundation](https://www.facebook.com/AARPFoundation)

 [@AARPFoundation](https://twitter.com/AARPFoundation)

AARP Foundation®

Copyright ©2026 by AARP Foundation.
All rights reserved.